

Charmfire®



CLASSIC CAST IRON STOVE RICHMOND

PART NO: 6909905

USER GUIDE

CE

ORIGINAL INSTRUCTIONS

GC0917 REV 4

INTRODUCTION

Thank you for purchasing this CLARKE Classic Cast Iron Stove.

Before attempting to install or operate the stove, it is essential that you read this manual thoroughly and carefully follow all instructions given. In doing so you will ensure the safety of yourself and that of others around you, and you can also look forward to the product giving you long and satisfactory service.

GUARANTEE

This CLARKE product is guaranteed against faulty manufacture for a period of 12 months from the date of purchase. Please keep your receipt as proof of purchase.

This guarantee is invalid if the product is found to have been abused or tampered with in any way, or not used for the purpose for which it was intended.

Faulty goods should be returned to their place of purchase, no product can be returned to us without prior permission. This guarantee does not effect your statutory rights.

SPECIFICATIONS

Weight	157 kg
Dimensions (W x H x D)	665 x 725 (top of body) x 475
Door Opening	375 x 295 mm
Flue Pipe required	150 mm/6 inch
Fuel	Wood/Coal
Nominal / Space Heat Output	9.2 kw (31,400BTU)
Gas Mass Flow	0.83 g/s
Measured CO@13% Oxygen	0.12%
Energy Efficiency	78% @18k w
Recommended chimney draft	12 Pa
Operation	Intermittent

INSTALLATION OF THIS PRODUCT



WARNING: AN ACCREDITED HEATING ENGINEER MUST CARRY OUT THE INSTALLATION OF THIS STOVE. ALTERNATIVELY, SHOULD A NON-ACCREDITED ENGINEER UNDERTAKE THE INSTALLATION, YOUR LOCAL BUILDING CONTROL OFFICER WILL BE REQUIRED TO APPROVE THE COMPLETED INSTALLATION UNDER BUILDING REGULATION "J". IT IS AN OFFENCE UNDER UK LAW, NOT TO COMPLY WITH THIS MANDATORY REQUIREMENT. IF THE STOVE IS NOT FITTED CORRECTLY BY AN APPROVED PERSON, IT COULD RESULT IN A HOUSE FIRE OR CARBON MONOXIDE POISONING.

READ ALL THE INSTRUCTIONS CAREFULLY BEFORE INSTALLATION



CAUTION: The instructions cover the basic principles to ensure satisfactory installation of the stove, although detail may need slight modification to suit particular site conditions. In all cases the installation must comply with current Building Regulation 'J', Local Authority By-laws, European and National standards and any other specifications or regulations as they affect the installation of the stove.

CAUTION: The information contained in this manual includes extracts from the Building Regulations 2000 "Approved Document J" (Combustion Appliances and Fuel Storage Systems), updated October 2010. This guidance information in no way replaces your responsibility as an installer or end user to comply with the appropriate standards.

SAFETY WARNINGS FOR YOUR GUIDANCE



WARNING: THIS STOVE WILL BE HOT WHEN IN OPERATION AND DUE CARE SHOULD BE TAKEN. THICK GLOVES SHOULD BE USED TO OPERATE THE PRIMARY/SECONDARY CONTROLS OR REACHING INSIDE THE STOVE TO POSITION FUEL OR REMOVE ASH.

CAUTION: FIRES CAN BE DANGEROUS - Always use a fireguard in the presence of children, the elderly or the infirm. The fireguard should be manufactured in accordance with B.S. 6539 - Fireguards for use with solid fuel appliances.

CAUTION: DO NOT OVERFIRE - it is possible to fire the stove beyond its design capacity. This could damage the stove, so watch for signs of overfiring - if any part of the stove starts to glow red, the stove is in an overfire situation and the controls should be adjusted accordingly. Never leave the stove unattended for long periods without first adjusting the controls to a safe setting. Careful air supply control should be exercised at all times.

CAUTION: THIS STOVE MUST BE CONNECTED TO A SUITABLE FLUE OUTLET. Due to high temperature this stove should be located well away from furniture and curtains. Children and adults should be alerted to the hazards of hot surfaces. Young children should be carefully supervised when they are in the same room as the stove. Do not place clothing or other flammable material on or near the stove. Keep the stove area clear of combustible materials, flammable liquids or vapours.

CAUTION: CARBON MONOXIDE POISONING CAN BE FATAL. Carbon Monoxide detectors to BS EN 50291 are available for use in domestic premises and details are available in the official HETAS guide that can be viewed on their website at www.hetas.co.uk. Due consideration should be given to the dangers of carbon monoxide poisoning following incomplete combustion of solid fuels in an enclosed space. See page 16 of this booklet.

GENERAL SAFETY RULES

1. Always read and understand the manual before installing and commissioning the stove.
2. Always ensure the stove is installed in accordance with local regulations.
3. Always ensure that the stove is correctly installed and positioned as described under POSITIONING AND INSTALLATION, and that the immediate area is kept clear.
4. Always check for damage before using the stove. Check for breakage of parts and any other condition that may affect the stoves performance. Any damage should be properly repaired or the part replaced. If in doubt, **DO NOT** use the stove. Consult your local dealer.
5. Always keep children and visitors at a safe distance from the stove.
6. Never direct any kind of liquid on to the stove, particularly when it is hot.
7. Never use gasoline or other flammable liquids for fire starting.
8. Never use the stove to incinerate materials other than recommended fuels.
9. Never carry out any modifications to this product. If experiencing difficulty of any kind consult your local dealer.
10. The installation of the stove and chimney **MUST** comply with all National, European and local building regulations. It is the responsibility of the owner and the installer to ensure that the installation complies.
11. All rooms where a stove is situated must have a non-motorised air vent. Refer to details contained in the Building Regulations.

IMPORTANT: Building Regulation "J" is the Government approved document covering the installation of solid fuel stoves.

ENVIRONMENTAL PROTECTION



Recycle unwanted materials instead of disposing of them as waste. All unwanted accessories and packaging should be sorted and taken to a recycling centre for disposal in a manner which is compatible with the environment.

UNPACKING & ASSEMBLY

UNPACKING



WARNING: DUE TO THE WEIGHT OF THE STOVE IT IS ADVISED THAT TWO PEOPLE PERFORM THE UNPACKING.

Unpack the stove and remove packing materials. Open the door and remove the loose items from inside the stove.

Before assembling, please check contents against the following list and advise your dealer immediately if any parts are missing. Refer also to parts list & diagram on pages 25 & 26.

- 1 x Stove body
- 4 x Legs
- 1 x Flue Blanking Plate
- 1 x Ashpan & Handle
- 1 x Flue Connector & fireproof Gasket
- 1 x Deflector Plate
- 1 x Grate
- 1 x Fixings Kit

TOOLS REQUIRED

- Clarke Fire Cement
- Phillips Screwdriver
- 13mm Spanner

A full range of flue pipes and fire cement is available from your Clarke dealer.

If there are any gaps between any of the cast iron panels or flue components, these should be filled with Clarke fire cement. This is necessary to prevent smoke or any other emissions. Clarke fire cement can be overpainted with Clarke stove paint.

ASSEMBLY

1. Place the stove on a soft surface such as the polystyrene packing materials from the crate, and tilt the stove back.
2. Attach the legs using the bolts and washers supplied as shown in Fig 1.
3. Sit the stove upright and attach the flue adaptor as shown in Fig 2 using the screws supplied. Ensure the fireproof gasket is correctly seated in the base of the adaptor.
4. Install the blanking plate in the rear of the stove when the normal flue exit is required.
 - If the rear mounting flue configuration is to be used, the blanking plate will be fitted to the top of the stove and the flue connector fitted to the rear panel.
5. Set the ashpan in position as shown in Fig 4. A handle is supplied for when the stove is in use.
6. Place stove in the desired location as shown in POSITIONING AND INSTALLATION. Take care not to damage the floor surface.
7. Ensure the deflector plate is correctly positioned between the front bracket and the rear baffle as shown in Fig 4.

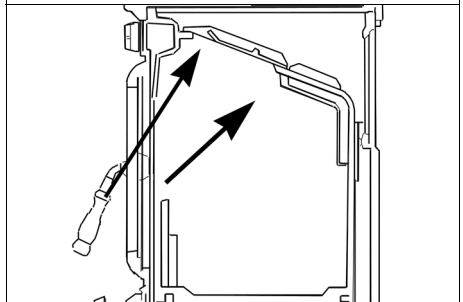
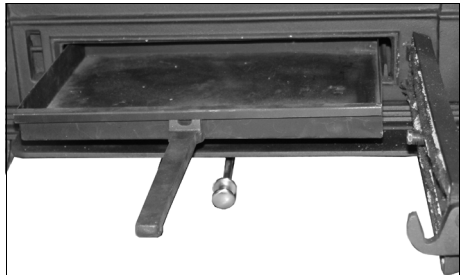
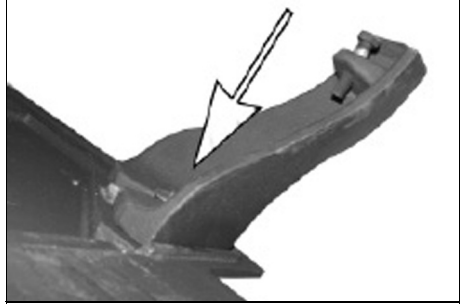

POSITIONING AND INSTALLATION

REGULATORY COMPLIANCE

In England and Wales, there are only two routes to legally install a domestic solid fuel or wood burning appliance. In other parts of the UK there are variations in legislation and processes.

You can either:

- Use a registered installer who can self certify that the work he does complies with the relevant Building Regulations; or:
- The consumer applies to their local authority building control department for a building notice, and pays the appropriate fee.

It is generally worthwhile to use a HETAS registered installer who will supply a Certificate of Compliance as a record of the job and that it complies with Building Regulations. A copy of the certificate is forwarded to HETAS who notify the local authority on your behalf.

Failure to notify the work through the registration scheme (in this case HETAS) or directly to the local authority can lead to enforcement. It can also cause problems for future house sales if there is no official record of a compliant installation. All local regulations, including those referring to National and European Standards need to be complied with when installing this appliance.

For specific guidance when cast iron stoves are being installed in boats or in homes with thatched roofs, please refer to the SOLIFTEC website at:

www.soliftec.com/installation.htm

SUPPORTING FLOORS

The stove must only be installed on floors with an adequate load bearing capacity and if the existing construction is not suitable, additional measures such as a load distributing plate must be provided.

The hearth should be able to accommodate the weight of the stove and its chimney if the chimney is not independently supported. Stoves should stand wholly above hearths made of non-combustible board/sheet material or tiles at least 12mm thick, if the stove is not to stand in a recess and has been tested to an applicable standard to verify that it cannot cause the temperature of the upper surface of the hearth to exceed 100°C.

Constructional hearths should be made of solid, non-combustible material such as concrete or masonry, at least 125mm thick, including the thickness of any non-combustible floor and/or decorative surface.

Specific guidance for surfaces on which the stove may be allowed to stand is given in Approved Document J and must be followed.

When the stove is positioned near a wall constructed of flammable material, the distances shown on Fig 4 must be adhered to. Alternatively, a heat shield may be used, mounted according to the position of the fireplace. A firewall must be at least 100 mm thick and typically made of brick, or concrete/stone.

MATERIAL CLEARANCES

The stove must have a minimum clearance of 1200 mm to a combustible ceiling above.

FIG 5

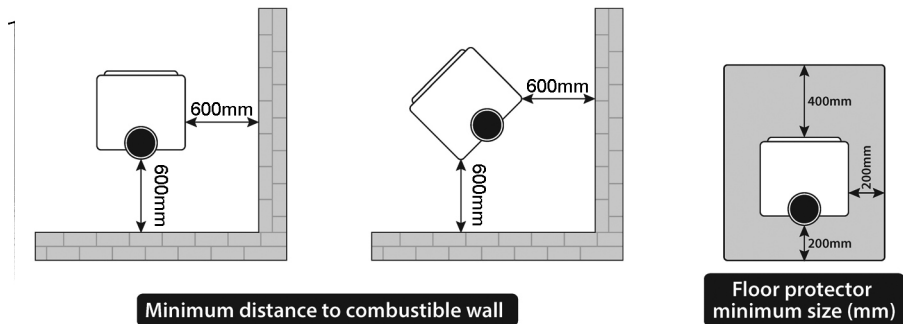

It is recommended that the stove be installed at least 600 mm from combustible materials which could be adversely affected by heat.

The stove can be recessed in a suitable sized fireplace but a permanent free air gap of at least 200 mm must be left around the sides and top and at least 200mm at the back of the stove to obtain maximum heat output and for access to the rear of the stove.

MINIMUM DISTANCE TO COMBUSTIBLE MATERIALS

Note: combustible material refers to any material that will degrade when subjected to heat e.g. plaster.

Due to the heat of a hot stove, a suitable fire guard should always be used to provide additional protection. Never allow young children to be left unsupervised in a room containing a hot stove.

Note; If in doubt, refer to the Building Regulations 2000 Approved Document "J".

CHIMNEY CONSTRUCTION

The stove is supplied with a top mounting flue pipe connector for. It should never be connected to a shared chimney/flue system.

Flue pipes with a smaller cross-sectional area than that of the stove outlet should never be used and must not project into the chimney connector, such as to cause a restriction to the gas flow.

Sizes of flues in chimneys are stipulated in Table 2 of the Building Regulations 2000 Approved Document "J" as follows:

1. Stoves under 20kW rated output which burn smokeless or low volatile fuel require a minimum flue size of 125 mm diameter (or rectangular flues having the same cross-sectional area and a minimum dimension not less than 100mm for straight flues or 125 mm for flues with bends or offsets.
2. Stoves of up to 30kW rated output burning any fuel require 150mm diameter (or rectangular flues having the same cross-sectional area and a minimum dimension not less than 125 mm.

Liners should be installed in accordance with their manufacturers instructions. Appropriate components should be selected to form the flue without cutting and to keep joints to a minimum. Bends and offsets should be formed only with the matching factory-made components. Liners need to be placed with the sockets or rebate ends uppermost to contain moisture and other condensates in the flue. Joints should be sealed with fire cement, refractory mortar or installed in accordance with their manufacturers instructions. Ensure the joints are completely sealed as air leakage will lead to poor performance. Avoid having more than two bends in the flue system. Any offset between bends should be minimised and the flue should be equipped with suitable access doors for inspection & cleaning. For further detail refer to Building Regulations document "J".

A range of suitable flue pipes, cowls and fire cement are available from your Clarke dealer.

Special methods are required when passing through a wall or ceiling. Please refer to your local building regulations and/or fire department. Refer to Building Regulations Document "J".



CAUTION: THIS STOVE MUST NOT BE INSTALLED INTO A CHIMNEY THAT SERVES ANY OTHER HEATING APPLIANCE. THERE MUST NOT BE AN EXTRACTOR FAN FITTED IN THE SAME ROOM AS THE STOVE, AS THIS CAN CAUSE THE STOVE TO EMIT FUMES INTO THE ROOM

FLUE HEIGHT

The chimney height and the position of the chimney should conform to the Building Regulations document "J". Flues should be high enough to clear the products of combustion. The height necessary for this will depend on the type of the stove, the height of the building, the type of flue and the number of bends in it, and an assessment of local wind patterns. However, a minimum flue height of 4.5m could be satisfactory if the guidance in paragraphs 2.10 to 2.12 of the Approved Document "J" is adopted.

External flue pipes should be "twin wall". These retain the heat, enabling it to rise and disperse from the chimney.

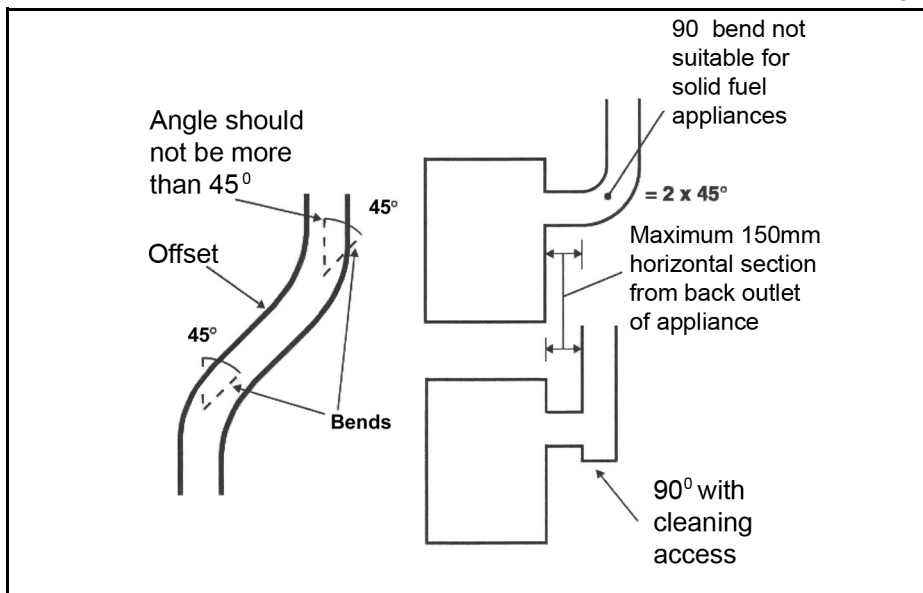

As an alternative approach, the calculation procedure within BS EN 13384-1 can be used as the basis for deciding whether a chimney design will provide sufficient draught. If in doubt, consult the Building Regulations.

The outlet from a flue should be above the roof of the building in a position where the products of combustion can discharge freely and will not present a fire hazard, whatever the wind conditions.

BENDS IN FLUES

Openings for inspection & cleaning should be formed using purpose factory-made components compatible with the flue system, having an access cover that has the same level of gas-tightness as the flue system and an equal level of thermal insulation.

Offsets in flues are only acceptable if the following rules are respected:

- The chimney system shall have no more than 4 bends in total; - 2 bends in the chimney and 2 bends in the flue pipe connection.
- The offset shall provide a change of direction no more than 45 degrees from the vertical.
- The run of the chimney between bends shall not exceed 20% of the total chimney length.
- Maximum length of horizontal flue must not exceed 150 mm (6").

INSPECTION & CLEANING

Check that the chimney is in good condition, dry and free from cracks and obstructions. The diameter of the chimney should not be less than 150mm and not more than 230 mm. If any of these requirements are not met, the chimney should be lined by a suitable method.

The chimney must be swept before connection to the stove. Where the chimney is believed to have previously served an open fire installation, it is possible that the higher flue gas temperature from the stove may loosen deposits that were previously firmly adhered, with the consequent risk of flue blockage. It is therefore recommended that the chimney be swept a second time within a month of regular use after installation.

Assuming that when the stove is first installed, the chimney is clean, and sound, then the chimney flue should be inspected part way through the burning season to establish the regularity of sweeping required. If you have any doubts about the suitability of your chimney, consult your local dealer/stockist.

If there is no existing chimney, then a prefabricated block chimney in accordance with Building Regulations Approved Document J, or a twin-walled insulated stainless steel flue to B.S.4543 can be used. These chimneys must be fitted in accordance with the manufacturer's instructions and Building Regulations.

FLUE DRAUGHT

A flue draught of approx 1.2 mm to 2.5 mm water gauge is required for satisfactory stove performance. The flue draught should be checked under fire at high output. If it exceeds the recommended maximum, a draught stabiliser must be fitted so that the rate of burning can be controlled to prevent over-firing. If the reading is less than the recommended minimum, then the performance of the stove will be compromised.

AIR FOR COMBUSTION

Any room or space containing a stove should have a permanent air vent opening of at least the sizes shown in the table below. For stoves designed to burn a range of different solid fuels, the air supply should be designed to accommodate burning the fuel that produces the highest heating output.

There must always be a permanent means of providing air for combustion into the room in which the fire is installed. A permanent vent with a total free area of at least 550 mm for every kW rated above 5 kW should be connected directly to the outside air or an adjacent room which itself has a permanent vent of the same size direct to the outside air.

The fitting of an extractor fan to either of these rooms is not permitted.

Stove Air Supplies	
Stove with flue draught stabiliser	Permanently open vents as below: If design air permeability > 5.0m ³ /(h.m ²) then 300mm ² /kW for first 5kW of appliance rated output. 850mm ² /kW for balance of appliance rated output. If design air permeability < 5.0m ³ /(h.m ²) then 850 mm ² /kW for balance of appliance rated output
Stove with no flue draught stabiliser	Permanently open vents as below: If design air permeability > 5.0m ³ /(h.m ²) then 550 mm ² /kW of appliance rated output above 5kW If design air permeability < 5.0m ³ /(h.m ²) then 550 mm ² /kW for balance of appliance rated output.

CONNECTION TO THE CHIMNEY

This MUST be carried out by an accredited/competent person and/or approved by your local Building Control Officer before using the stove.

Any existing flue must be in good condition with suitable access for collection and removal of debris. Details of suitable linings for use with solid fuel are given in the Official HETAS guide that can be viewed on their website at www.hetas.co.uk

It is also important that suitable flue pipe complying with Building Regulations is used to connect the stove to the chimney flue and that suitable access is provided into the flue for regular inspection and sweeping of the flueways.

Chimneys should be as straight as possible. Horizontal runs should be avoided except where the rear outlet of the appliance is used, in which case, the horizontal section should not exceed 150mm (6 inches) in length. Refer to the typical installation diagrams, Fig 7-10. Flue connections must be well sealed.

There are several ways of connecting the stove to the flue as shown in Figures 7-10. If the vertical rear flue is used, the chimney may be swept through the appliance. If it is not possible to pass the sweeps brush through the stove, a soot door will be necessary. This may be either in the actual brickwork of the chimney or fitted in the register plate. Various suitable positions of soot doors are shown in Figures 7-10.

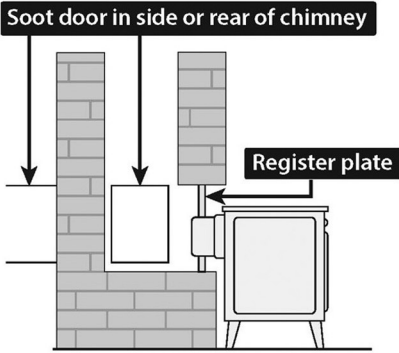

Vertical register plate with bricked-up fireplace

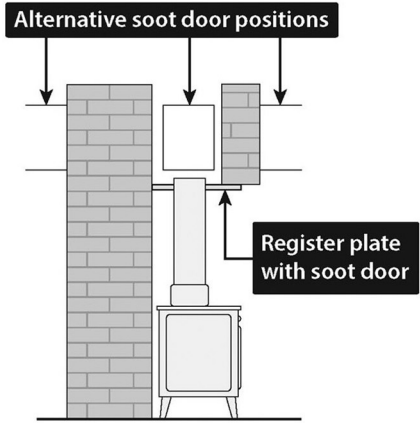

Horizontal register plate with top flue connection

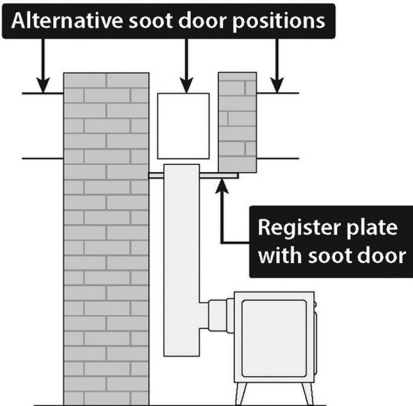

Horizontal register plate with rear flue connection

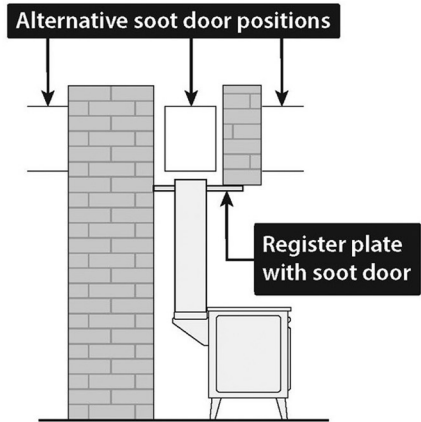

Horizontal register plate with optional vertical rear flue connection

A non-combustible register plate minimum 1.5 mm thick should be fitted to all installations between the flue and the building structure. It's suitability and fit should be checked by a qualified stove installation engineer against the current Building Regulations App"J".

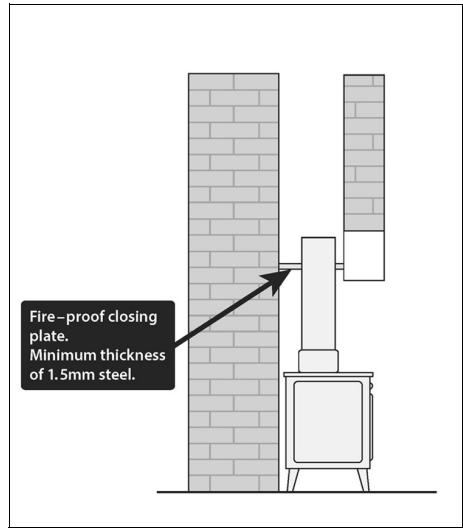

FIG 11

CLEANING THE FLUE

Access for cleaning the flue should be incorporated in the system other than through the appliance (e.g. a soot door or access through a register plate). Purpose-made soot doors and inspection lengths are available from the Clarke range.

Ensure that the whole length of the flue can be reached from the soot door.

FUME EMISSIONS

To avoid chimney problems, your fire should not be burnt slowly for longer than 12 hours without a period of fast burning.

Properly installed and operated, this stove will not emit fumes although occasional fumes from de-ashing and refuelling may occur. Persistent fume emission must not be tolerated and if fume emission persists, the following immediate action should be taken:-

1. Open doors and windows to ventilate room.
2. Let the fire out, or eject and safely dispose of fuel from the stove.
3. Check for flue chimney blockage and clean if required.
4. Do not attempt to re-light the fire until the cause has been identified and corrected.

If necessary, seek professional advice.

IMPORTANT: Never fit an extractor fan in the same room as this stove.

CARBON MONOXIDE ALARMS

Due consideration should be given to the dangers of carbon monoxide poisoning following incomplete combustion of solid fuels in an enclosed space. Carbon monoxide detectors to BS EN 50291 are available for use in domestic premises and details are available in the official HETAS guide that can be viewed on their website at www.hetas.co.uk.

Where a new or replacement fixed solid fuel appliance is installed in a dwelling, a carbon monoxide alarm should be provided in the room where the appliance is located.

Carbon monoxide alarms should comply with BS EN 50291 and be powered by a battery, designed to operate for the working life of the alarm. The alarm should incorporate a warning device to alert users when the working life of the alarm is due to pass. Mains-powered BS EN 50291 Type A carbon monoxide alarms with fixed wiring (not plug-in types) may be used as alternative applications, provided they are fitted with a sensor failure warning device.

The carbon monoxide alarm should be located in the same room as the stove:

- on the ceiling at least 300 mm from any wall or, if located on a wall, as high up as possible (above any doors and windows) but not within 150mm of the ceiling and;
- between 1m and 3m horizontally from the stove.

NOTE: Further guidance on the installation of carbon monoxide alarms is available in BS EN 50292 and from manufacturers instructions. Provision of an alarm should not be regarded as a substitute for correct installation and regular servicing.

USING YOUR STOVE

THE STOVE CONTROLS



WARNING: THE TEMPERATURE REACHED BY THESE ITEMS DURING OPERATION MAY CAUSE AN INJURY TO AN END-USER. AS THESE ARE INTENDED TO BE ADJUSTED DURING OPERATION, IT IS RECOMMENDED THAT A PROTECTIVE MITT IS WORN WHEN HANDING THESE PARTS.

The amount of heat emitted by the stove is regulated using the following air controls.

- The primary air supply is controlled using the lower air control built into the door.
- A second air inlet provides a constant, pre-heated air supply to the combustion just above the fire. This is controlled using the upper air control mounted near the top of the stove. This air supply will not normally need to be regulated so will usually be kept open. The air wash effect will help keep the window glass clean.

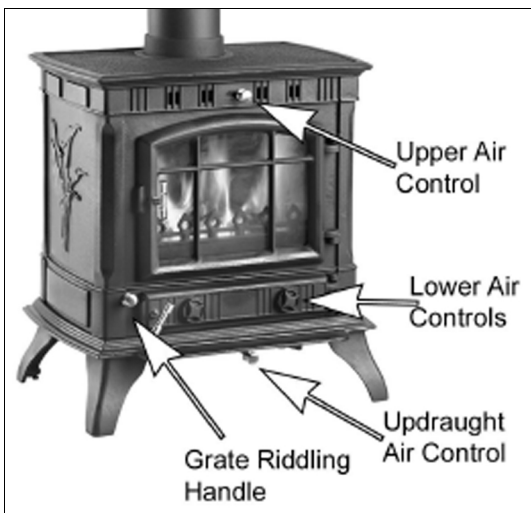

- An additional air inlet is provided in the base of the stove. This is controlled using the knob at the bottom of the stove to provide a gentle updraught from the back of the stove to the chimney flue.
- The knob on the left is for riddling (moving) the grate panel to dislodge any accumulation of loose ash into the ash pan.

TYPES OF FUEL

This stove will function with wood or coal, but in general all fuel should be dry and timber should be well seasoned so as to have a moisture content below 20%. The use of damp wood will result in more soot and tar deposits being left in the chimney, flu and stove, and will not release heat if thermal energy is being used to drive out moisture from the fuel.

Other fuels can be used together with wood, provided the base of the fire remains as wood or compressed block fuels. Coal products can be added to

this provided the volume of coal products is less than that of other fuels.

With solid fuels, there is less need to burn the stove hard after refuelling. The rate of refuelling will also be less often than with wood.

Avoid using the stove to incinerate other materials including household waste. Avoid using 'green' unseasoned wood, treated wood such as telegraph poles, or plywood / chipboard containing glues and resins which pollute the environment and cause the fire to burn too quickly.

Such materials can produce excessive tar or creosote which can be damaging and in extreme cases cause a fire inside the chimney.

The dryness of wood can be assessed by looking at the end of the log. Radial cracks, deep enough to be considered as splits should be present in dry, seasoned logs.

The maximum length of fuel suitable for this stove is approx 40 cm so as to lay flat over the embers, and logs of greater than 10 cm diameter should be split.

Confirm with your fuel provider as to which type will suit best. Larger fuels will allow a greater draught in the firebox which will speed up combustion. Household coal produces more ash & chimney deposits than smokeless fuels.

For further information on type and availability of fuel, the Solid Fuel Association (<http://www.solidfuel.co.uk>) serves as an advice centre to domestic consumers including all aspects of fuel types.

The UK Smoke Control Areas website (<http://www.uksmokecontrolareas.co.uk>) defines the location of smoke controlled areas throughout England, Scotland, Wales and Northern Ireland and lists all fuels which are authorised for use in Smoke Control Areas. However, you should check with your local council to confirm that you can use a stove in a smoke controlled area.

INITIAL SEASONING:



CAUTION: THIS STOVE MUST BE SEASONED BEFORE USE. FAILURE TO CARRY OUT THIS IMPORTANT PROCEDURE WILL RESULT IN PERMANENT DAMAGE TO THE STOVE AND WILL VOID YOUR WARRANTY.

Following installation, and before regular use, the stove must be seasoned to prevent cracking of the metal casting. This procedure should also be followed if the stove has not been used for prolonged periods (during the summer months for example) and is carried out as follows:

1. Light a small fire in the middle of the stove, well away from the sides.
2. Allow the stove to warm up slowly and evenly with the air controls almost closed, avoiding intense flames.

3. Keep the fire burning for three hours or so, gradually increasing the size of the fire using larger logs which will burn naturally but slowly, keeping the stove on a low setting.
4. After a couple of days burning at this level, increase the brightness & intensity of the fire gradually over the next 10 days.

Full strength fires should not be used until completion of approx 20 days of mild use. Only from this time will the stove have been properly seasoned.

It should be remembered that this procedure should be carried out at the beginning of each season of use in order to remove the moisture retained by the metal during the period of non-use.

When used for the first time the fireplace may smell a little, due to gas being given off. The gas is not toxic but the room should be thoroughly ventilated. Let the fire burn with a high draught until no smells can be detected.

Take care not to open the stove doors too vigorously in case of causing smoke spillage. If smoke spillage occurs after the fire door has been opened this could be due to poor chimney draft. SEE TROUBLESHOOTING.

FIRE-LIGHTING WITH SOLID FUEL

1. Open the air controls.
2. Lay firelighters or rolled up newspapers in the stove with a reasonable quantity of dry kindling wood. Place a small quantity of solid fuel on top.
3. Light the newspaper or firelighters using a long taper and close the door.
4. When the fire is burning strongly add further fuel.
5. When the stove is hot, reduce the opening of the air control.
6. The burn rate can be reduced by partially closing the air controls.

FIRE-LIGHTING WITH WOOD

1. Open the air control.
2. Lay firelighters or rolled up newspapers on the grate with a reasonable quantity of dry kindling wood. Place 2 or 3 small logs on top.
3. Light the newspaper or firelighters using a long taper and close the door.
4. When the fire is burning strongly add further logs up to 10 cm diameter.
5. When the stove is really hot, close the air control as required. Ensure there are lasting flames until the wood becomes charcoal.

REFUELLING

1. Always open the door slowly to avoid a sudden rush of intake air and smoke escaping into the room and add fuel.

2. Open the air controls and leave open for a few minutes to allow the gasses in the wood to burn before closing the air controls.
 - The rate of refuelling and heat available are dependant upon individual requirements based upon the user's experience. When re-loading, it is normally necessary to burn the stove fast initially, to drive off any gasses and moisture, before closing the air vents to control the burn rate.
 - Ensure the door is kept closed to contain fumes except when lighting up, re-fuelling or removing ash.
 - It is not recommended to leave the stove alight at night or to continue using the stove in mild weather which gives poor combustion leading to a greater buildup of soot.
 - If overnight burning is required, it can best be achieved by first driving off any gasses or moisture as usual, following a full charge of fuel and then closing the air vents fully. Experience will indicate the optimum setting. However, by reducing the burn rate to such a level that the fire is still burning the following day, the burning process creates heavy, tarry chemicals which will become deposited on the inside of the flue or chimney. This is an inefficient process which greatly increases the risk of a chimney fire and makes it necessary to sweep the chimney more often.

ASH REMOVAL

Keep the stove free from a heavy buildup of ash. The frequency of this is dependant upon the type and quality of fuel being used. Ash should be removed before it builds up to the underside of the grate, at which point, the grate would be burning hot on both sides, shortening its life expectancy.

When disposing of ashes, ensure they have cooled and always place in a metal container. Be sure to remove the ash when the fire is at its lowest point, such as first thing in the morning.

The Clarke Ash Can Filter is ideal for use in conjunction with the Clarke range of vacuum cleaners, for collecting hot ash and debris from stoves.

MAINTENANCE

CLEANING

The inside of the stove may require regular cleaning, especially during periods of peak use, the frequency of this being indicated by experience. It is advisable to wear a dust mask, protective gloves and safety glasses when cleaning.

Use a stiff brush and industrial type vacuum cleaner to dislodge and remove as much material as possible, starting at the top of the stove and working

down to the bottom. Particular attention should be given to the air inlet controls which can become obstructed. A CVAC Ash Can Filter and vacuum cleaner is ideal for this process.

GENERAL MAINTENANCE

Take this opportunity to check for any damaged parts inside the stove. In the event of damage or broken components, replacements can be obtained from Clarke Parts & Service. On no account should unauthorised spare parts be used.

The stove and flueway should be inspected and maintained when in a cold condition. NO unauthorised modification of this product should be carried out. This stove requires regular maintenance by a competent engineer.

STOVE BODY

The stove is finished with a heat-resistant paint which can be cleaned with a soft brush. Wait until the stove has cooled down before doing this. This finish can be renovated with Clarke stove paint, although the paint may not be an exact match and it may be necessary to repaint the complete stove.

If the stove is purely ornamental, painting will provide a durable, attractive finish. If the stove is used for heating, a high temperature heat resistant paint (available from your Clarke dealer) must be used, in either aerosol or brush applied form. Should rust become apparent, clean thoroughly with a wire brush and apply a suitable anti-rust treatment.

During prolonged periods out of use, the air inlet should be left open and the door left slightly ajar in order to circulate fresh air and discourage condensation from forming which could encourage corrosion.

FIRE ROPE

Check the rope around the door and glass. If rope is becoming detached, replace with rope approved for this purpose.

Inspect the fireproof door seal where fitted, to ensure there is an effective seal around the door and re-fix it if loose using stove rope adhesive. If in poor condition it should be replaced.

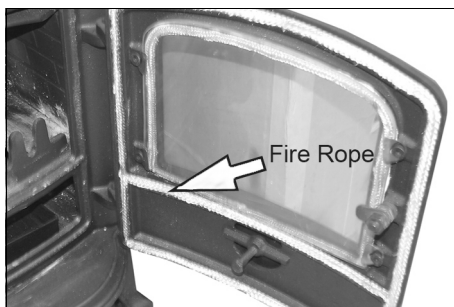

GLASS PANELS

Clean any glass panel when cool, avoiding abrasive substances which could scratch the glass and make subsequent cleaning more difficult. Wet logs against a heated glass, a badly aimed poker or heavy slamming of the door could crack the glass panel. The glass will not fracture with heat. Never replace any broken glass with glass NOT approved for use with stoves.

The window glass should remain clean during normal use but it can become blackened if the stove is being operated with either damp fuels or at a slow burn rate. The blackening may be dispersed by burning briefly at a much higher temperature, or it may be cleaned off using specialist glass cleaner.

In the event of the glass being broken, it can be removed by unscrewing the retaining tabs, taking care not to damage the fireproof rope seal. The replacement glass should be carefully placed against the seal and the retaining tabs re-tensioned. Take care to tension these evenly or there is a risk of breaking the new glass pane.

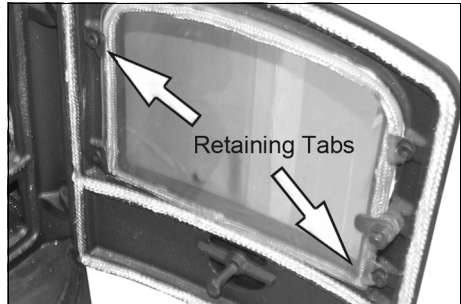

CHIMNEYS AND FLU-WAYS

It is important that the chimney, flu-ways and any connecting flue pipe are swept regularly. This means at least once a year for smokeless fuels and at least twice a year for wood and other fuels.

Only wire-centred sweep's brushes fitted with a guide wheel should be used. If it is not possible to sweep all parts of the chimney through the stove, ensure there is adequate access to cleaning doors.

If the stove is fitted in place of an open fire, then the chimney should be swept one month after installation to clear any soot falls which may have occurred, due to the difference in combustion performance between the stove and the open fire.

The flue and chimney should be inspected for a build-up of deposits especially following prolonged periods without use. The entire chimney/flue should be swept frequently from top to bottom by a registered chimney sweep to remove any build-up of soot etc, the frequency being dependant upon the usage and the fuels being burnt. If the chimney is swept after a few weeks of regular use, the condition found will give an indication of the frequency of sweeping required. On an annual basis, the chimney is best swept just before the main winter burning season.

HETAS recommends that chimney sweeping is best carried out by an approved chimney sweep who will normally be a member of the National Association of Chimney Sweeps or the Guild of Master Sweeps, details of which can be found on the HETAS website, www.hetas.co.uk.

ACCESSORIES

Refer to the Clarke website www.clarkeinternational.com for a full range of Flue Pipes & Cowls for use with this classic cast iron stove. See also the following accessories;

Fire Cement (1Kg tubs)	Part No: 6910000
Ash Can Filter	Part No: 6471130
Paper Briquette Maker	Part No:1801617
Matt Black Stove Paint (500 ml)	Part No: 6910200
Electric Log Splitters;	
Logbuster 5	Part No 3402030
Stand also available	Part No 3402045
See also Logbusters 4, 6, 7 & 8	

TROUBLESHOOTING

PROBLEM	CAUSE	SOLUTION
Fire difficult to start.	Wood green, too damp or poor quality.	Use recommended fuel.
Fire goes out.	Logs are too large.	When lighting, use small, dry kindling. To maintain the fire use split logs.
	Air starvation	Open air control.
	Insufficient draught.	Check that flue is not obstructed, sweep flue if necessary.
Fire burns too quickly.	Too much draught.	Ensure the air control is closed.
		Install a draught stabiliser. Consult your dealer.
		Do not continuously burn small wood, sticks, carpentry offcuts, plywood etc
Stove smokes when lighting up.	Flue duct is cold.	Burn paper and kindling wood to increase heat.
	Room is at negative air pressure to the outside.	In houses equipped with mechanical ventilation, open a window until the fire is well established.
Low heat output.	Incorrect fuels.	Use recommended fuels.
Smokes while burning	Draught is insufficient	Consult a chimney specialist. Check that flue is not obstructed. Sweep if necessary.
	Downdraught present.	Install an anti-downdraught cowl. Consult your dealer.
	Room is at negative pressure to outside.	In houses equipped with mechanical ventilation, an outside air intake must be installed in the chimney.
Smoke spillage when opening door.	Chimney not tall enough to be clear of roof line.	Increase height of chimney.
	Poor sealing of flue-pipe joints.	Re-connect flue or replace jointing material
	Flue is partially blocked with soot.	Arrange to have chimney swept.
	House too tightly sealed.	Ensure a fresh air supply is reaching the stove.

COMPONENT PARTS DIAGRAM

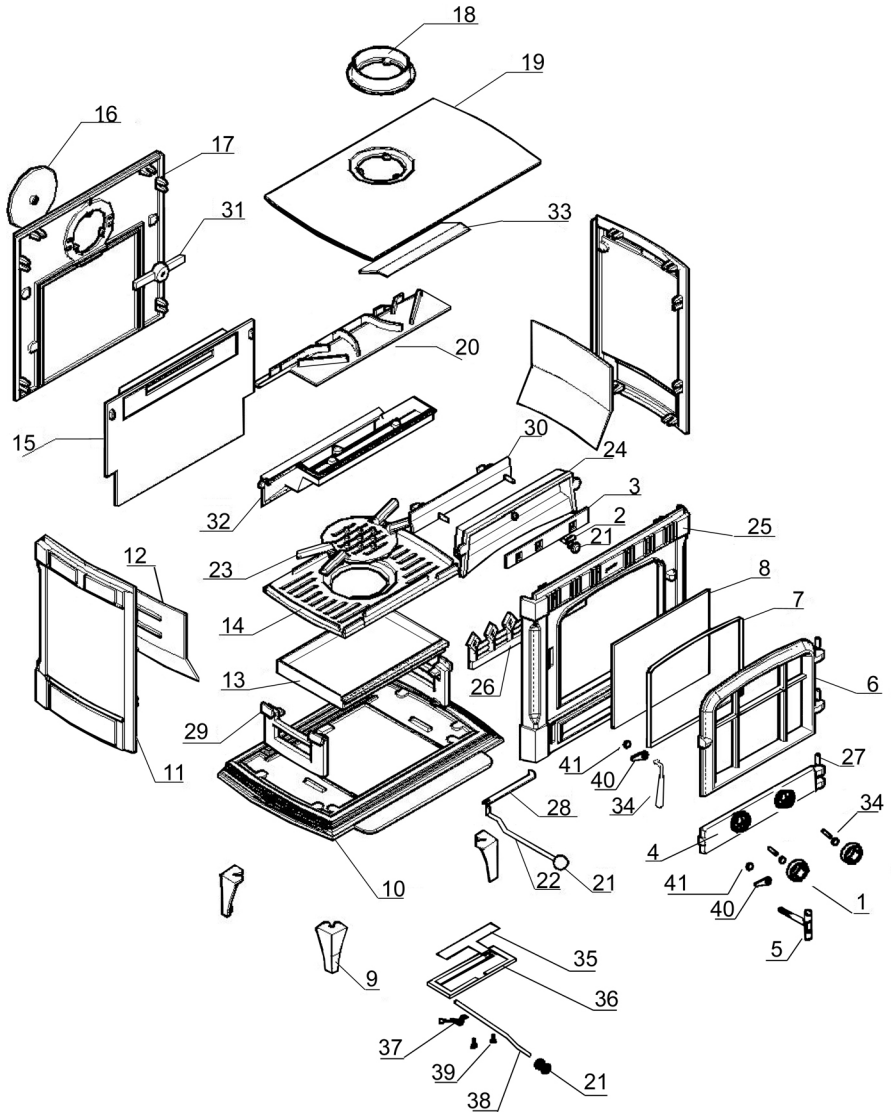

COMPONENT PARTS LIST

P/No	DESCRIPTION
1	Air Control Vent
2	Spring
3	Draught Adjuster
4	Ashpan Door
5	Ashpan Door Handle
6	Door Frame
7	Fireproof Gasket
8	Window Glass
9	Leg
10	Baseplate
11	Sideplate
12	Side Firebrick
13	Blanking Plate
14	Grate Baseplate
15	Back Firebrick
16	Backing Plate
17	Back Plate
18	Flue Adaptor
19	Top Plate
20	Secondary Air Chamber
21	Knob

P/No	DESCRIPTION
22	Riddling Control Arm
23	Riddling Grate
24	Air Plate
25	Front Plate
26	Log Retainer
27	Door Hinge Pin
28	Riddling Operating Arm
29	Grate Frame Holding Piece
30	Secondary Airside Deflector
31	Blanking Plate Clamp
32	Secondary Air Chamber
33	Air Baffle Plate
34	Adjusting Bolt
35	Air Regulator Plate
36	Air Regulator Frame
37	Support for Regulator Rod
38	Regulator Rod
39	Fixing Screw
40	Latch Arm
41	Locking Nut

DECLARATION OF CONFORMITY



Clarke[®]
INTERNATIONAL

Hemnal Street, Epping, Essex CM16 4LG

DECLARATION OF CONFORMITY

This is an important document and should be retained.

We hereby declare that this product(s) complies with the following directive(s):

89/106/EEC Construction Products Directive

The following standards have been applied to the product(s):

EN 13240:2001/A2:2004

The technical documentation required to demonstrate that the product(s) meet(s) the requirement(s) of the aforementioned directive(s) has been compiled and is available for inspection by the relevant enforcement authorities.

The CE mark was first applied in: 2007

Product Description: Solid Fuel Stove

Model number(s): Richmond

Serial / batch Number: N/A

Date of Issue: 26/10/09

Signed:

J.A. Clarke
Director

WE ALSO SUPPLY A GREAT SELECTION OF *Clarke* PRODUCTS TO USE WITH YOUR STOVE AND TO HELP YOU PREPARE YOUR STOVE AND LOGS



Fire Screen, Log Basket & Companion Set



Paper Briquette Maker

Log Trolley with Cover



LOG SAWS & SPLITTERS



Electric Chain Saw

COMPANION SETS



Black enamel & stainless steel flue pipes & cowls (B.S. approved)

ASHCANS

Fire Cement



FLUES, PIPES AND COWLS

CHAINSAWS

FIRESCREENS

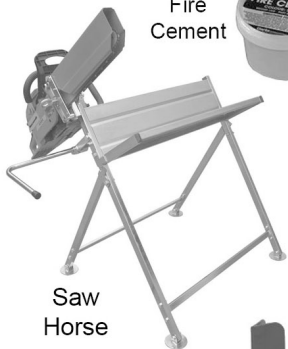

Saw Horse



Log Rack

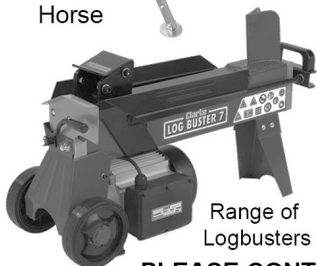

Range of Logbusters



Ash-can Vacuum cleaner



Stove paint & cleaners



PLEASE CONTACT YOUR LOCAL *Clarke* STOCKIST FOR ANY OF THESE ITEMS

PARTS & SERVICE: 020 8988 7400

E-mail: Parts@clarkeinternational.com or Service@clarkeinternational.com

SALES: UK 01992 565333 or Export 00 44 (0)1992 565335

***Clarke* INTERNATIONAL** Hemnall Street, Epping, Essex CM16 4LG
www.clarkeinternational.com